



MANTUA 32"

Category: Bathroom Vanity

Material: Wood

Dimensions:

31.5"(W) x 19.8"(D) x 16.0"(H)

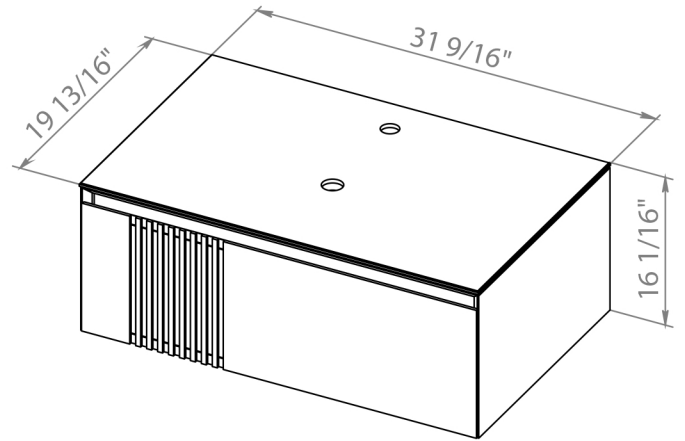

Technical Data

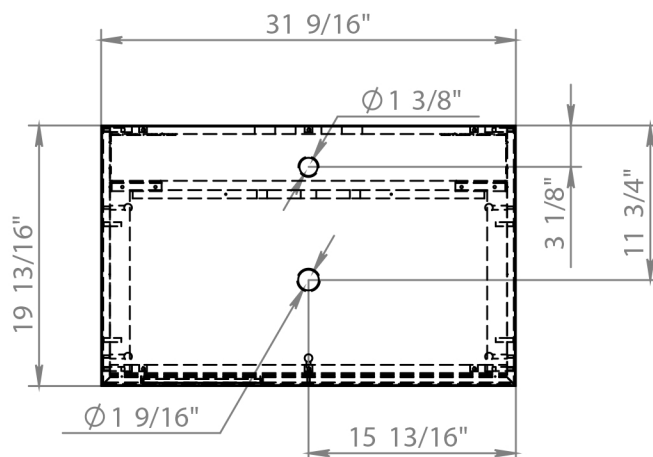
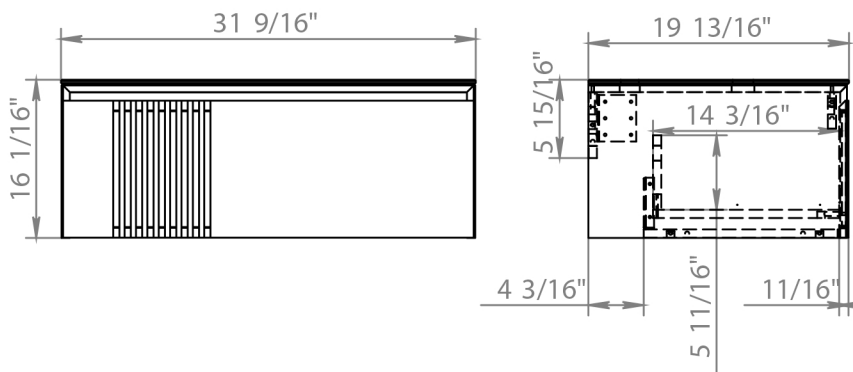

*Numbers are in inches

TOOLS REQUIRED FOR ASSEMBLY

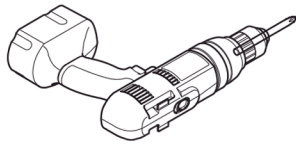

Electrical Drill

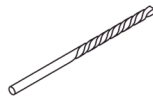

Drill Bit

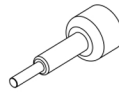

Bolt Bit

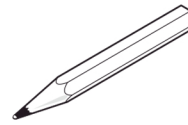

Pencil

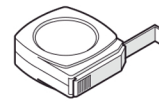

Tape Measure



Phillips
Screwdriver

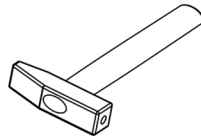

Hammer

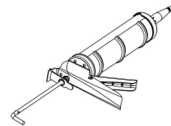

Silicone

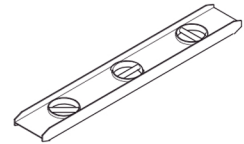

Level

FURNITURE

A

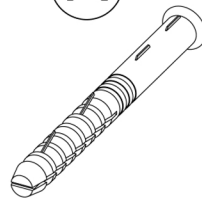

4 PCS

B

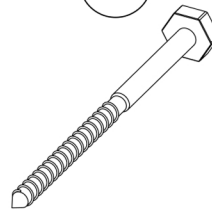

4 PCS

Wall Preparation

The recommended height for a console cabinet with sink is 33-1/2". This requires installing a 14" wide wood panel to a height of 34-1/4". If an alternate height desired, adjust the rough-in and backing material heights using the dimensions provided.

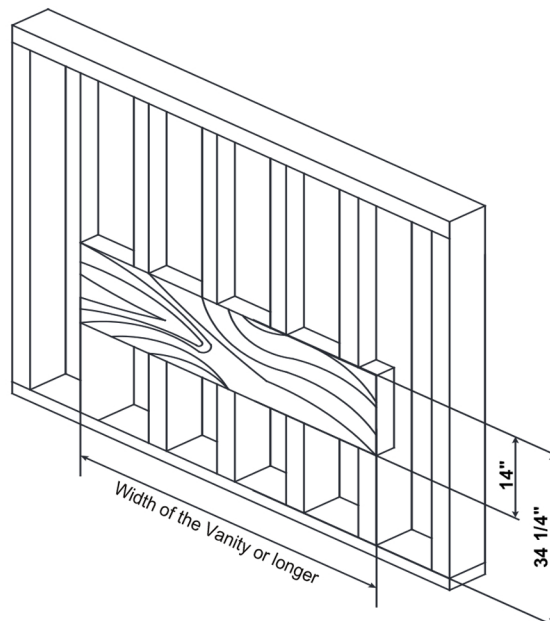

STEP 1. Marking for the cabinet
Having decided on the location of the cabinet, we mark and drill holes in the wall measuring the distance A, B, C

WARNING:
Before installing the cabinet must be removed drawers.

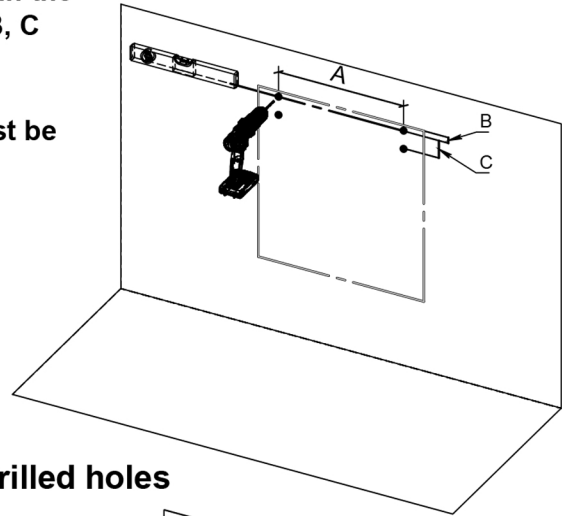

STEP 2. Install the cabinet on the drilled holes

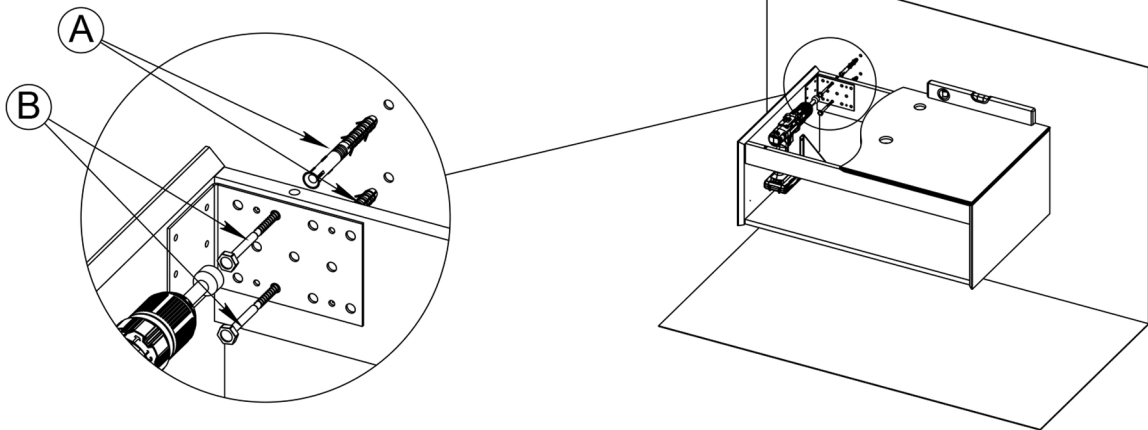

STEP 3. Fill the side against the wall with Silicone and finish

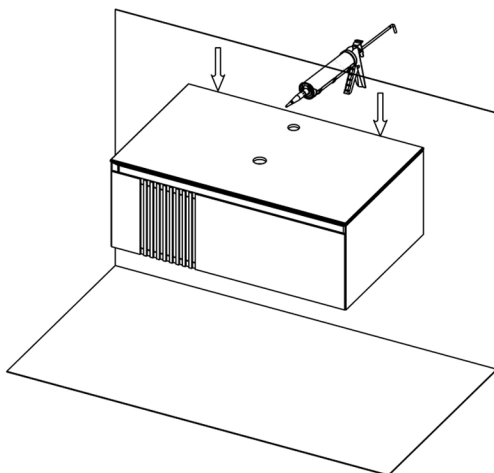

STEP 4. Install sink top with Silicone

